



Características Técnicas

Pressão máx.	50 Bar
Temp. de trabalho °C	-20 à 180
Material do corpo	Inox 316

Propriedades Mecânicas

Resistência à tração Ksi (MPa)	limite de Escoamento Ksi (Mpa)	Alongamento em 2" ou 50mm %
70 (485) Mín.	30 (205) Mín.	30,0 Mín

Tolerância do diâmetro externo (mm)

Ø	30	30 ~ 50	50 ~ 75	75 ~ 100	100 ~ 150	150 ~ 200	200 ~ 300	300
Tolerância	0,9	1,0	1,1	1,2	1,4	1,5	1,8	2,0

Niple Duplo Liso

Código	Ø	L	SW
NIL-01	1/8"	10.2	40.0
NIL-02	1/4"	13.5	40.0
NIL-03	3/8"	17.2	40.0
NIL-04	1/2"	21.3	60.0
NIL-06	3/4"	26.9	60.0
NIL-10	1"	33.7	60.0
NIL-12	1-1/4"	42.4	80.0
NIL-15	1-1/2"	48.3	80.0
NIL-20	2"	60.3	100.0
NIL-25	2-1/2"	76.1	120.0
NIL-30	3"	88.9	120.0
NIL-40	4"	114.3	150.0

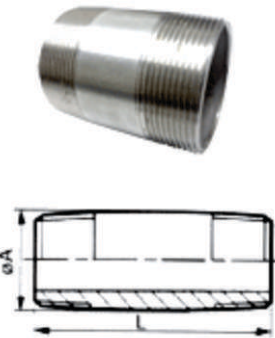

Ponta Roscada

Código	Ø	L	SW
NIL-01S	1/8"	10.2	30.0
NIL-02S	1/4"	13.5	30.0
NIL-03S	3/8"	17.2	30.0
NIL-04S	1/2"	21.3	35.0
NIL-06S	3/4"	26.9	40.0
NIL-10S	1"	33.7	40.0
NIL-12S	1-1/4"	42.4	50.0
NIL-15S	1-1/2"	48.3	50.0
NIL-20S	2"	60.3	50.0
NIL-25S	2-1/2"	76.1	60.0
NIL-30S	3"	88.9	70.0
NIL-40S	4"	114.3	80.0

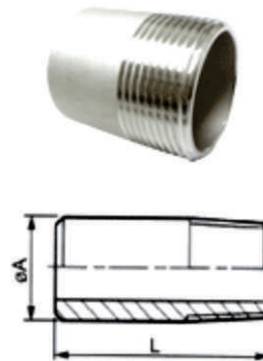

Luva Lisa c/ Rosca Fêmea

Código	Ø	ØA	L
LI-01	1/8"	15.0	17.0
LI-02	1/4"	18.5	25.0
LI-03	3/8"	21.3	26.0
LI-04	1/2"	27.7	34.0
LI-06	3/4"	33.6	36.0
LI-10	1"	39.5	43.3
LI-12	1-1/4"	49.0	48.0
LI-15	1-1/2"	55.0	48.0
LI-20	2"	67.0	56.0
LI-25	2-1/2"	83.1	65.6
LI-30	3"	100.0	71.0
LI-40	4"	123.5	83.5

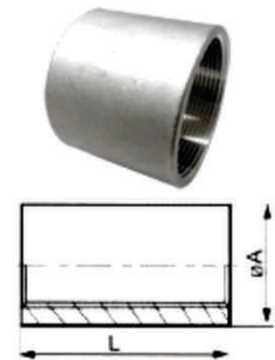

Luva c/ Encaixe p/ Solda

Código	Ø	ØA	L
LI-01S	1/8"	15.0	24.4
LI-02S	1/4"	18.8	26.9
LI-03S	3/8"	21.8	29.5
LI-04S	1/2"	26.7	34.0
LI-06S	3/4"	33.0	37.0
LI-10S	1"	40.9	42.4
LI-12S	1-1/4"	47.2	49.0
LI-15S	1-1/2"	55.1	54.9
LI-20S	2"	69.6	64.2
LI-25S	2-1/2"	84.6	73.2
LI-30S	3"	103.6	80.8
LI-40S	4"	129.0	93.7

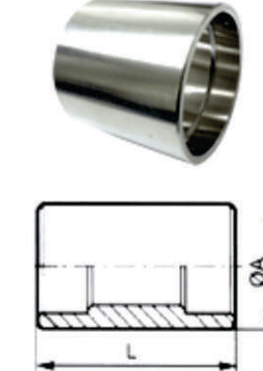



Conexões em Inox



Meia-Luva Rosca Fêmea				
Código	Ø	ØA	L	
LI-01M	1/8"	15.0	10.0	
LI-02M	1/4"	18.5	11.0	
LI-03M	3/8"	21.3	12.0	
LI-04M	1/2"	27.7	15.5	
LI-06M	3/4"	33.6	17.4	
LI-10M	1"	39.5	20.0	
LI-12M	1-1/4"	49.0	22.0	
LI-15M	1-1/2"	55.0	22.0	
LI-20M	2"	67.0	26.9	
LI-25M	2-1/2"	82.9	31.0	
LI-30M	3"	96.0	34.0	
LI-40M	4"	123.6	39.0	



Cotovelo 90° c/ Rosca Macho/Fêmea					
Código	Ø	ØA	L	L1	
CIMF-01	1/8"	15.0	26.0	19.0	
CIMF-02	1/4"	18.0	28.3	19.0	
CIMF-03	3/8"	23.0	35.0	22.5	
CIMF-04	1/2"	29.0	42.0	29.0	
CIMF-06	3/4"	35.0	50.5	33.0	
CIMF-10	1"	43.0	52.0	38.0	
CIMF-12	1-1/4"	52.0	60.0	45.0	
CIMF-15	1-1/2"	58.0	65.0	50.0	
CIMF-20	2"	71.0	74.0	58.0	
CIMF-25	2-1/2"	87.0	99.5	68.0	
CIMF-30	3"	96.0	115.5	78.0	
CIMF-40	4"	121.0	146.5	97.0	

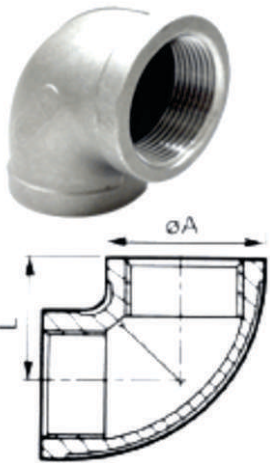

Cotovelo 90° c/ Rosca Fêmea				
Código	Ø	ØA	L	
CIF-01	1/8"	18.0	17.6	
CIF-02	1/4"	21.3	20.0	
CIF-03	3/8"	23.5	21.3	
CIF-04	1/2"	29.0	27.0	
CIF-06	3/4"	35.0	33.0	
CIF-10	1"	43.0	38.0	
CIF-12	1-1/4"	52.0	45.0	
CIF-15	1-1/2"	58.0	50.0	
CIF-20	2"	71.0	58.0	
CIF-25	2-1/2"	86.5	69.3	
CIF-30	3"	99.0	77.5	
CIF-40	4"	125.0	97.3	

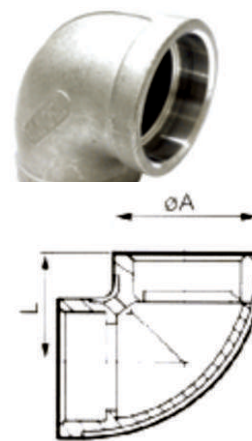

Cotovelo 90° c/ Encaixe p/ Solda				
Código	Ø	ØA	L	
CI-01S	1/8"	18.0	17.6	
CI-02S	1/4"	21.3	20.0	
CI-03S	3/8"	23.5	21.3	
CI-04S	1/2"	29.0	27.0	
CI-06S	3/4"	35.0	33.0	
CI-10S	1"	43.0	38.0	
CI-12S	1-1/4"	52.0	45.0	
CI-15S	1-1/2"	58.0	50.0	
CI-20S	2"	71.0	58.0	
CI-25S	2-1/2"	86.5	69.3	
CI-30S	3"	99.0	77.5	
CI-40S	4"	125.0	97.3	



Cotovelo 45° c/ Rosca Fêmea				
Código	Ø	ØA	L	
CIFK-01	1/8"	18.0	17.5	
CIFK-02	1/4"	21.0	19.4	
CIFK-03	3/8"	26.0	20.7	
CIFK-04	1/2"	29.0	22.0	
CIFK-06	3/4"	35.0	25.0	
CIFK-10	1"	43.0	28.0	
CIFK-12	1-1/4"	52.0	33.0	
CIFK-15	1-1/2"	58.0	36.0	
CIFK-20	2"	71.0	43.0	
CIFK-25	2-1/2"	86.5	48.5	
CIFK-30	3"	99.0	53.8	
CIFK-40	4"	125.0	64.7	

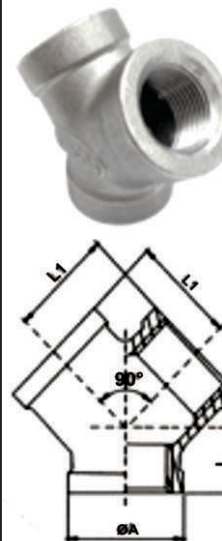

Te 45° c/ Rosca Fêmea					
Código	Ø	ØA	L	L1	
KIY-01	1/8"	17.0	10.0	17.0	
KIY-02	1/4"	21.0	13.0	19.0	
KIY-03	3/8"	25.0	14.0	23.0	
KIY-04	1/2"	29.0	18.0	27.0	
KIY-06	3/4"	35.0	20.0	32.0	
KIY-10	1"	43.0	23.0	38.0	
KIY-12	1-1/4"	52.0	28.0	46.0	
KIY-15	1-1/2"	58.0	30.0	48.0	
KIY-20	2"	71.0	34.0	57.0	
KIY-25	2-1/2"	88.0	40.0	68.0	
KIY-30	3"	101.0	45.0	78.0	
KIY-40	4"	129.0	52.0	97.0	



Conexões em Inox

Cruzeta c/ Rosca Fêmea			
Código	Ø	ØA	L
XI-01	1/8"	15.2	17.0
XI-02	1/4"	19.7	19.0
XI-03	3/8"	23.3	22.9
XI-04	1/2"	28.0	26.8
XI-06	3/4"	34.8	32.0
XI-10	1"	43.6	37.5
XI-12	1-1/4"	53.0	45.9
XI-15	1-1/2"	58.0	47.6
XI-20	2"	71.0	56.3
XI-25	2-1/2"	87.0	69.0
XI-30	3"	99.0	78.0
XI-40	4"	125.0	97.0

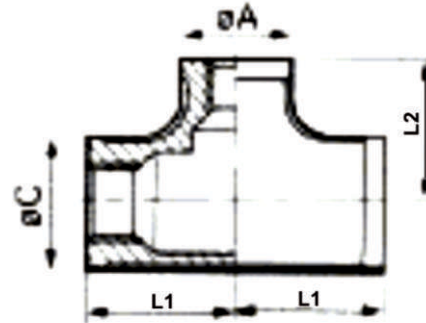

Te 90° c/ Encaixe p/ Solda			
Código	Ø	ØA	L
TI-01S	1/8"	18.0	17.0
TI-02S	1/4"	21.3	21.0
TI-03S	3/8"	23.5	23.6
TI-04S	1/2"	30.8	28.5
TI-06S	3/4"	37.0	33.4
TI-10S	1"	43.5	37.5
TI-12S	1-1/4"	54.5	44.5
TI-15S	1-1/2"	62.0	49.5
TI-20S	2"	74.8	57.0
TI-25S	2-1/2"	86.6	68.7
TI-30S	3"	99.2	77.8
TI-40S	4"	125.0	97.0

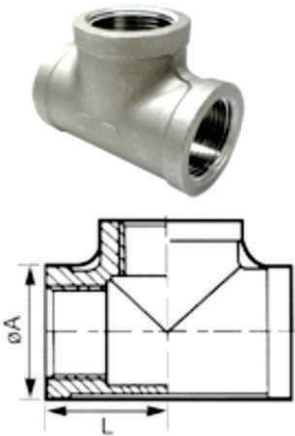

Te 90° de Redução c/ Rosca Fêmea					
Código	Ø	L1	L2	ØA	ØC
TIFR-04-01	1/2" x 1/8"	22.0	23.0	16.9	28.8
TIFR-04-02	1/2" x 1/4"	24.0	24.0	20.8	28.8
TIFR-04-03	1/2" x 3/8"	26.0	25.0	23.3	28.8
TIFR-06-02	3/4" x 1/4"	25.0	27.0	20.8	35.8
TIFR-06-03	3/4" x 3/8"	28.0	28.0	23.3	35.8
TIFR-06-04	3/4" x 1/2"	30.0	31.5	30.0	37.0
TIFR-10-02	1" x 1/4"	28.0	31.0	20.8	43.3
TIFR-10-03	1" x 3/8"	30.0	31.0	23.3	43.3
TIFR-10-04	1" x 1/2"	32.0	33.4	30.5	44.0
TIFR-10-06	1" x 3/4"	34.0	35.0	35.5	43.3
TIFR-12-03	1-1/4" x 3/8"	32.0	36.0	23.3	51.4
TIFR-12-04	1-1/4" x 1/2"	34.0	38.0	28.8	61.4
TIFR-12-06	1-1/4" x 3/4"	38.0	40.0	40.0	51.4
TIFR-12-10	1-1/4" x 1"	40.0	42.0	42.0	51.4
TIFR-15-03	1-1/2" x 3/8"	34.0	40.0	40.0	57.9
TIFR-15-04	1-1/2" x 1/2"	35.0	42.0	42.0	57.9
TIFR-15-06	1-1/2" x 3/4"	38.0	43.0	43.0	57.9
TIFR-15-10	1-1/2" x 1"	41.0	45.0	45.0	57.9
TIFR-12-12	1-1/2" x 1-1/4"	45.0	48.0	48.0	57.9
TIFR-20-04	2" x 1/2"	38.0	48.0	48.0	70.6
TIFR-20-06	2" x 3/4"	41.0	49.0	49.0	70.6
TIFR-20-10	2" x 1"	44.0	51.0	51.0	70.6
TIFR-20-12	2" x 1-1/4"	48.0	54.0	54.0	70.6
TIFR-20-15	2" x 1-1/2"	52.0	55.0	55.0	70.6

Te 90° c/ Rosca Fêmea			
Código	Ø	ØA	L
TIF-01	1/8"	18.0	17.0
TIF-02	1/4"	21.3	21.0
TIF-03	3/8"	23.5	23.6
TIF-04	1/2"	30.8	28.5
TIF-06	3/4"	37.0	33.4
TIF-10	1"	43.5	37.5
TIF-12	1-1/4"	54.4	44.5
TIF-15	1-1/2"	62.0	49.5
TIF-20	2"	74.8	57.0
TIF-25	2-1/2"	86.6	68.7
TIF-30	3"	99.2	77.8
TIF-40	4"	125.0	97.0

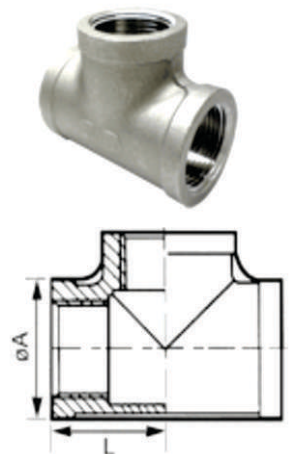

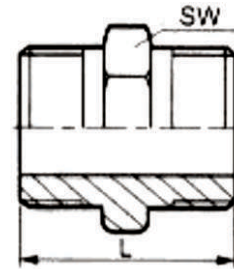
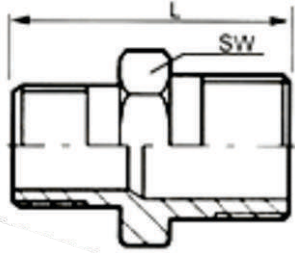

Niple Duplo Sextavado de Redução

Código	Ø	L	SW
NI-02-01	1/4" x 1/8"	34.0	18.0
NI-03-01	3/8" x 1/8"	36.0	21.0
NI-03-02	3/8" x 1/4"	34.0	21.0
NI-04-01	1/2" x 1/8"	34.0	26.0
NI-04-02	1/2" x 1/4"	34.0	26.0
NI-04-03	1/2" x 3/8"	41.0	26.0
NI-06-01	3/4" x 1/8"	37.0	30.0
NI-06-02	3/4" x 1/4"	37.0	30.0
NI-06-03	3/4" x 3/8"	37.0	30.0
NI-06-04	3/4" x 1/2"	45.0	30.0
NI-10-02	1" x 1/4"	39.0	35.0
NI-10-03	1" x 3/8"	40.0	35.0
NI-10-04	1" x 1/2"	43.2	35.0
NI-10-06	1" x 3/4"	50.0	37.0
NI-12-03	1-1/4" x 3/8"	46.0	46.0
NI-12-04	1-1/4" x 1/2"	48.0	46.0
NI-12-06	1-1/4" x 3/4"	52.0	46.0
NI-12-10	1-1/4" x 1"	54.0	46.0
NI-15-03	1-1/2" x 3/8"	48.0	50.0
NI-15-04	1-1/2" x 1/2"	49.0	50.0
NI-15-06	1-1/2" x 3/4"	53.0	50.0
NI-15-10	1-1/2" x 1"	53.0	50.0
NI-15-12	1-1/2" x 1-1/4"	59.0	50.0
NI-20-04	2" x 1/2"	52.0	63.0
NI-20-06	2" x 3/4"	56.0	63.0
NI-20-10	2" x 1"	57.0	63.0
NI-20-13	2" x 1-3/4"	58.0	63.0
NI-20-15	2" x 1-1/2"	64.0	64.0
NI-25-10	2-1/2" x 1"	63.0	80.0
NI-25-12	2-1/2" x 1-1/4"	66.0	80.0
NI-25-15	2-1/2" x 1-1/2"	66.0	80.0
NI-25-20	2-1/2" x 2"	77.0	76.3
NI-30-10	3" x 1"	68.0	95.0
NI-30-12	3" x 1-1/4"	72.0	95.0
NI-30-15	3" x 1-1/2"	72.0	95.0
NI-30-20	3" x 2"	74.0	95.0
NI-30-25	3" x 2-1/2"	84.0	95.0
NI-40-12	4" x 1-1/4"	82.0	125.0
NI-40-15	4" x 1-1/2"	82.0	125.0
NI-40-20	4" x 2"	82.0	125.0
NI-40-25	4" x 2-1/2"	82.0	125.0
NI-40-30	4" x 3"	94.0	117.4

Niple Duplo Sextavado c/ Rosca BSP

Código	Ø	L	SW
NI-01	1/8"	23.6	12.0
NI-02	1/4"	27.8	16.0
NI-03	3/8"	28.0	19.0
NI-04	1/2"	34.0	21.6
NI-06	3/4"	40.0	30.0
NI-10	1"	46.0	36.0
NI-12	1-1/4"	52.5	46.0
NI-15	1-1/2"	54.0	50.0
NI-20	2"	62.0	65.5
NI-25	2-1/2"	70.0	79.5
NI-30	3"	78.4	90.0
NI-40	4"	94.0	120.0

Niple Duplo Sextavado c/ Rosca NPT

Código	Ø	L	SW
NI-01N	1/8"	29.0	12.0
NI-02N	1/4"	32.5	17.0
NI-03N	3/8"	36.0	20.0
NI-04N	1/2"	42.5	26.0
NI-06N	3/4"	46.0	32.0
NI-10N	1"	51.5	38.0
NI-12N	1-1/4"	56.0	46.0
NI-15N	1-1/2"	59.0	52.5
NI-20N	2"	65.0	65.0
NI-25N	2-1/2"	80.0	77.0
NI-30N	3"	90.0	92.0
NI-40N	4"	107.0	118.0

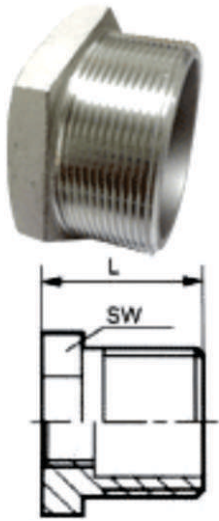

Buchas de Redução Sextavada			
Código	Ø	L	SW
BRI-02-01	1/4" x 1/8"	15.2	16.0
BRI-03-01	3/8" x 1/8"	16.5	18.0
BRI-03-02	3/8" x 1/4"	16.5	18.0
BRI-04-01	1/2" x 1/8"	21.0	26.0
BRI-04-02	1/2" x 1/4"	21.0	26.0
BRI-04-03	1/2" x 3/8"	21.0	26.0
BRI-06-02	3/4" x 1/4"	24.0	30.0
BRI-06-03	3/4" x 3/8"	24.0	30.0
BRI-06-04	3/4" x 1/2"	24.0	30.0
BRI-10-02	1" x 1/4"	27.0	35.0
BRI-10-03	1" x 3/8"	27.0	35.0
BRI-10-04	1" x 1/2"	27.0	35.0
BRI-10-06	1" x 3/4"	27.0	35.0
BRI-12-04	1-1/4" x 1/2"	30.0	45.0
BRI-12-06	1-1/4" x 3/4"	30.0	45.0
BRI-12-10	1-1/4" x 1"	30.0	45.0
BRI-15-03	1-1/2" x 3/8"	36.0	52.0
BRI-15-04	1-1/2" x 1/2"	36.0	52.0
BRI-15-06	1-1/2" x 3/4"	36.0	52.0
BRI-15-10	1-1/2" x 1"	36.0	52.0
BRI-15-12	1-1/2" x 1-1/4"	36.0	52.0
BRI-20-02	2" x 1/4"	36.0	63.0
BRI-20-04	2" x 1/2"	36.0	63.0
BRI-20-06	2" x 3/4"	36.0	63.0
BRI-20-10	2" x 1"	36.0	63.0
BRI-20-12	2" x 1-1/4"	36.0	63.0
BRI-20-15	2" x 1-1/2"	36.0	63.0
BRI-25-10	2-1/2" x 1"	45.0	63.0
BRI-25-12	2-1/2" x 1-1/4"	45.0	81.0
BRI-25-15	2-1/2" x 1-1/2"	45.0	81.0
BRI-25-20	2-1/2" x 2"	45.0	81.0
BRI-30-15	3" x 1-1/2"	47.0	81.0
BRI-30-20	3" x 2"	47.0	95.0
BRI-35-25	3" x 2-1/2"	47.0	95.0
BRI-40-20	4" x 2"	52.0	119.0
BRI-40-25	4" x 2-1/2"	52.0	119.0
BRI-40-30	4" x 3"	52.0	119.0

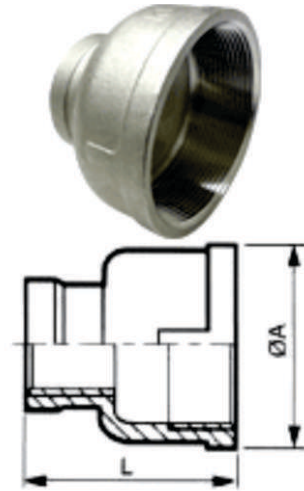

Luva de Redução c/ Rosca Fêmea			
Código	Ø	ØA	L
LI-02-01	1/4" x 1/8"	21.5	26.0
LI-03-01	3/8" x 1/8"	22.6	30.0
LI-03-02	3/8" x 1/4"	26.0	29.0
LI-04-01	1/2" x 1/8"	29.4	34.4
LI-04-02	1/2" x 1/4"	29.7	33.0
LI-04-03	1/2" x 3/8"	29.0	34.0
LI-06-01	3/4" x 1/8"	36.7	38.0
LI-06-02	3/4" x 1/4"	36.5	34.5
LI-06-03	3/4" x 3/8"	36.8	36.5
LI-06-04	3/4" x 1/2"	36.7	37.0
LI-10-01	1" x 1/8"	43.7	41.7
LI-10-02	1" x 1/4"	43.7	42.0
LI-10-03	1" x 3/8"	46.3	42.7
LI-10-04	1" x 1/2"	44.7	42.8
LI-10-06	1" x 3/4"	43.0	42.0
LI-12-04	1-1/4" x 1/2"	52.5	49.0
LI-12-06	1-1/4" x 3/4"	54.5	48.0
LI-12-10	1-1/4" x 1"	52.5	52.0
LI-15-03	1-1/2" x 3/8"	59.0	47.0
LI-15-04	1-1/2" x 1/2"	59.0	51.0
LI-15-06	1-1/2" x 3/4"	59.5	48.5
LI-15-10	1-1/2" x 1"	59.0	53.0
LI-15-12	1-1/2" x 1-1/4"	59.4	53.0
LI-20-04	2" x 1/2"	70.5	50.5
LI-20-06	2" x 3/4"	72.5	51.0
LI-20-10	2" x 1"	72.8	56.0
LI-20-12	2" x 1-1/4"	72.0	56.0
LI-20-15	2" x 1-1/2"	72.0	57.0
LI-25-10	2-1/2" x 1"	86.7	60.0
LI-25-12	2-1/2" x 1-1/4"	86.5	60.0
LI-25-15	2-1/2" x 1-1/2"	86.7	60.0
LI-25-20	2-1/2" x 2"	86.8	60.8
LI-30-10	3" x 1"	100.0	62.0
LI-30-12	3" x 1-1/4"	99.0	62.0
LI-35-15	3" x 1-1/2"	99.0	62.0
LI-30-20	3" x 2"	98.0	62.0
LI-30-25	3" x 2-1/2"	100.0	62.0
LI-40-25	4" x 2-1/2"	128.0	65.0
LI-40-30	4" x 3"	128.0	65.0

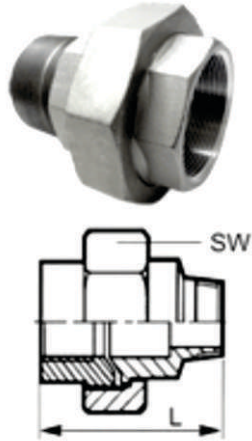

União c/ Assento Integral Rosca Macho/Fêmea			
Código	Ø	L	SW
UIMF-02	1/4"	50.0	28.5
UIMF-03	3/8"	52.5	33.5
UIMF-04	1/2"	61.5	38.5
UIMF-06	3/4"	64.5	46.0
UIMF-10	1"	71.5	51.0
UIMF-12	1-1/4"	82.0	63.5
UIMF-15	1-1/2"	95.0	75.0
UIMF-20	2"	103.0	92.0
UIMF-25	2-1/2"	123.0	110.0
UIMF-30	3"	125.5	120.0

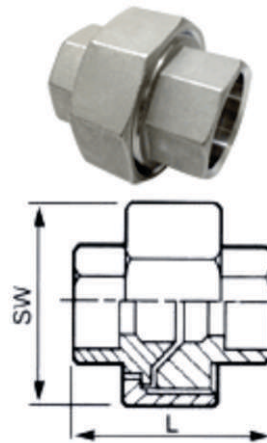

União c/ Assento Integral Encaixe p/ Solda			
Código	Ø	L	SW
UI-01S	1/8"	29.0	25.0
UI-02S	1/4"	37.5	30.0
UI-03S	3/8"	38.0	35.0
UI-04S	1/2"	42.0	42.0
UI-06S	3/4"	50.4	47.0
UI-10S	1"	48.0	53.0
UI-12S	1-1/4"	59.0	71.0
UI-15S	1-1/2"	64.0	78.0
UI-20S	2"	69.0	92.0
UI-25S	2-1/2"	80.0	112.0
UI-30S	3"	88.0	126.0
UI-40S	4"	108.0	157.0

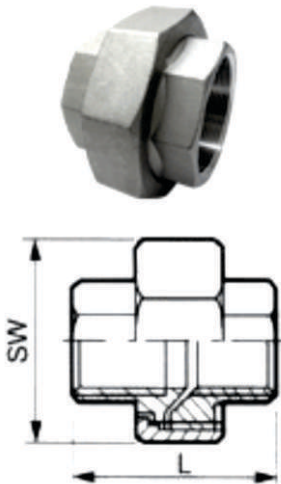

União c/ Assento Integral Rosca Fêmea			
Código	Ø	L	SW
UIF-01	1/8"	29.0	25.0
UIF-02	1/4"	37.5	30.0
UIF-03	3/8"	38.0	35.0
UIF-04	1/2"	42.0	42.0
UIF-06	3/4"	50.4	47.0
UIF-10	1"	48.0	53.0
UIF-12	1-1/4"	59.0	71.0
UIF-15	1-1/2"	64.0	78.0
UIF-20	2"	69.0	92.0
UIF-25	2-1/2"	80.0	112.0
UIF-30	3"	88.0	126.0
UIF-40	4"	108.0	157.0

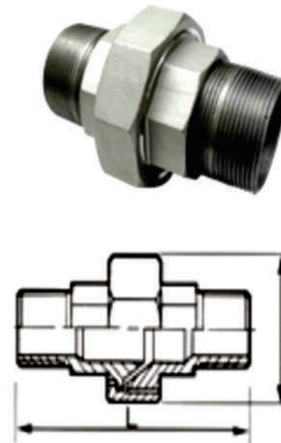

União c/ Assento Integral Rosca Macho			
Código	Ø	L	SW
UIM-01	1/8"	52.0	28.5
UIM-02	1/4"	61.0	30.0
UIM-03	3/8"	62.5	35.0
UIM-04	1/2"	73.0	42.0
UIM-06	3/4"	82.0	47.0
UIM-10	1"	90.0	53.0
UIM-12	1-1/4"	104.0	71.0
UIM-15	1-1/2"	109.6	78.0
UIM-20	2"	118.0	92.0
UIM-25	2-1/2"	145.0	112.0
UIM-30	3"	164.0	126.0
UIM-40	4"	205.0	157.0

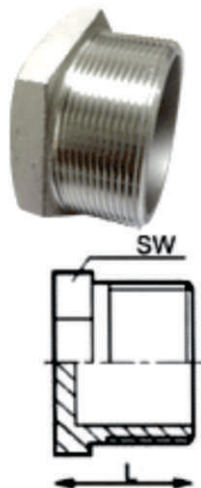

Bujão Cabeça Sextavada			
Código	Ø	L	SW
BIX-01	1/8"	17.0	12.0
BIX-02	1/4"	17.5	16.0
BIX-03	3/8"	18.0	20.0
BIX-04	1/2"	25.0	24.0
BIX-06	3/4"	26.0	30.0
BIX-10	1"	29.0	38.0
BIX-12	1-1/4"	35.0	46.0
BIX-15	1-1/2"	38.0	52.0
BIX-20	2"	39.0	65.0
BIX-25	2-1/2"	44.0	81.0
BIX-30	3"	54.0	94.0
BIX-40	4"	55.0	119.0

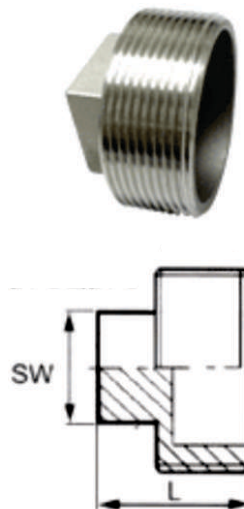

Bujão Cabeça Quadrada			
Código	Ø	L	SW
BIQ-01	1/8"	19.0	6x6
BIQ-02	1/4"	20.0	9x9
BIQ-03	3/8"	22.0	11x11
BIQ-04	1/2"	25.0	13x13
BIQ-06	3/4"	27.0	16x16
BIQ-10	1"	32.0	20x20
BIQ-12	1-1/4"	35.0	24x24
BIQ-15	1-1/2"	37.0	25x25
BIQ-20	2"	38.0	32x32
BIQ-25	2-1/2"	48.0	42x42
BIQ-30	3"	52.0	46x46
BIQ-40	4"	62.0	58x58



Conexões em Inox

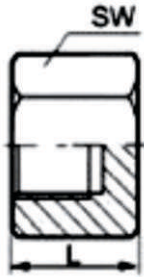

Tampão Sextavado			
Código	Ø	L	SW
BIXF-01	1/8"	13.0	15.0
BIXF-02	1/4"	17.0	18.0
BIXF-03	3/8"	19.0	21.0
BIXF-04	1/2"	20.0	27.0
BIXF-06	3/4"	24.0	30.0
BIXF-10	1"	25.0	38.0
BIXF-12	1-1/4"	28.0	50.0
BIXF-15	1-1/2"	28.0	55.0
BIXF-20	2"	34.0	70.0
BIXF-25	2-1/2"	40.0	92.0
BIXF-30	3"	45.0	109.0
BIXF-40	4"	50.0	132.0



Contra-Porca Sextavada			
Código	Ø	L	SW
PIX-01	1/8"	6.0	14.0
PIX-02	1/4"	7.0	23.0
PIX-03	3/8"	8.0	26.0
PIX-04	1/2"	10.0	31.0
PIX-06	3/4"	11.0	37.0
PIX-10	1"	10.0	46.0
PIX-12	1-1/4"	11.0	55.0
PIX-15	1-1/2"	12.0	63.0
PIX-20	2"	13.0	76.0
PIX-25	2-1/2"	16.0	95.0
PIX-30	3"	19.0	105.0
PIX-40	4"	20.0	131.0

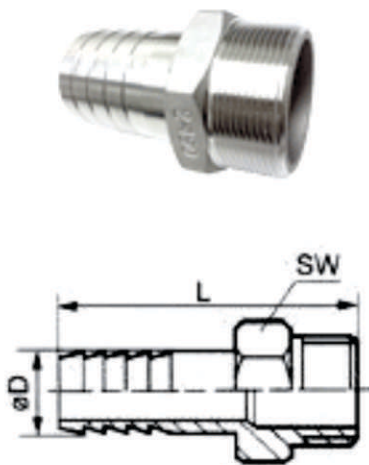

Espigão					
Código	Ø	L	SW	ØD	
EI6-01	1/8"	45.0	12.5	6.5	4.5
EI9-02	1/4"	47.0	16.5	9.0	6.35
EI11-03	3/8"	55.0	20.0	11.0	9.5
EI14-04	1/2"	64.0	23.0	14.0	12.7
EI20-06	3/4"	68.0	31.0	20.5	19.05
EI27-10	1"	71.0	38.5	27.0	25.4
EI33-12	1-1/4"	80.0	46.0	33.0	31.8
EI39-15	1-1/2"	95.0	52.0	39.5	38.1
EI52-20	2"	105.0	62.0	52.0	50.8
EI67-25	2-1/2"	107.0	80.0	67.0	63.5
EI80-30	3"	112.0	91.0	80.0	76.2
EI105-40	4"	130.0	116.5	105.0	101.6